

Bellini

INSTALLATION & OPERATION INSTRUCTIONS



60cm/90cm Black Fascia Canopy Range hood Model No.

BDRA603TBX FINELINE: 5102976 AUS

BDRA603TBX-F FINELINE: 0220236 NZ

BDRA903TBX FINELINE: 5102977 AUS

BDRA903TBX-F FINELINE: 0220233 NZ

Thank you

Thank you for choosing Bellini Appliances.

Bellini prides itself on 'affordable living' making sure there is no compromise in your favourite room ... The Kitchen

All Bellini appliances carry a 3 year In Home warranty, be sure to retain your installation and user manual and receipt.

For all warranty and technical queries please contact

1300 373 199

Content

Safety instructions-----	2
Product description-----	4
Installation-----	6
Start using your Range hood-----	11
Maintenance and cleaning -----	12
Warranty-----	13

Safety instructions

This manual explains the proper installation and use of your range hood, please read it carefully before using even if you are familiar with the product. The manual should be kept in a safe place for future reference. In case of failure, only the Authorised Technical Service may repair this range hood. Otherwise the guarantee will be null and void. All Bellini Appliances are for domestic use only.

Never to do:

- This appliance is not intended for use by persons (including children) with reduced physical, sensory and mental capabilities, or lack of experience and knowledge, unless they have been given supervision or instruction concerning use of the appliance by a person responsible for their safety.
- Never carry out flammable cooking under the appliance
- The exhaust from the range hood must not be discharged into any heating flue, which may carry combustion products from other sources.



- Do not leave lit gas burners exposed due to the risk of fire.



- This range hood is not recommended for barbecues.

Always to do:

- Packaging materials (eg; polystyrene and plastic items) must be kept out of reach of babies or young children at all times due to risk of suffocation.
- Young children should be supervised to ensure that they do not play with the appliance.
- Ensure the range hood is switched off before carrying out maintenance, to avoid any possibility of electric shock.
- Grease filters must be removed every four weeks (maximum) for cleaning to reduce the risk of fire.
- There must be adequate ventilation of the room when the range hood is used at the same time as appliances burning gas or other fuels.
- Always cover lit gas burners with pots or pans when range hood is in use.
- Always switch off gas burners before you remove pots or pans.
- If the supply cord is damaged, the cord must be replaced by the manufacturer, its service agent or similarly qualified persons in order to avoid a hazard
- Plug must be accessible after installation.

Safety instructions

Never to do:

- This range hood cannot be installed for outdoor use.
- It is prohibited to fit the range hood over a solid fuel stove
- This appliance must not be connected to a chimney or vent flue which is in use.
- This appliance is not to be vented into the roof cavity, must exit into open air.
- Exhaust air must not be discharged into a wall cavity, unless the cavity is designed for the purpose.
- This appliance should not be connected to ducting which ventilates rooms with fire places.

Always to do:

- Attention should be given to ensure that any applicable regulations concerning discharge of exhaust air are fulfilled.
- This appliance should be installed and maintained by a suitably qualified and competent person in accordance with the relevant safety regulations.
- Before connecting the appliance to the mains supply, ensure that the voltage and frequency details on the rating plate are consistent with the source of supply.







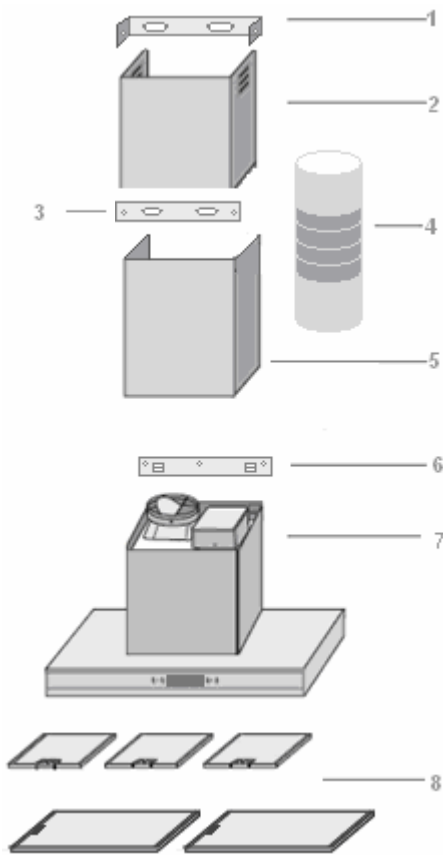

This product must not be disposed together with domestic waste. This product has to be disposed at an authorised place for recycling of electrical and electronic appliances.

By collecting and recycling waste, you help save natural resources, and make sure the product is disposed in an environmental friendly and healthy way.



BDRA603TBX, BDRA603TBX-F, BDRA903TBX, BDRA903TBX-F

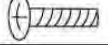
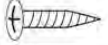
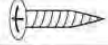

Accessories bag		
Description	Picture	QTY
User Manual		1
Upper decorative chimney bracket		1
Lower decorative chimney bracket		1
Hood mount bracket		1
Dry wall anchors plugs		9
Screw(ST4x8mm)		4
Screw(ST4x40mm)		7
Screw (ST4x30mm)		2
Flap		2
Strap		1

Component list:

1. Upper decorative chimney bracket
2. Upper decorative chimney(Inner)
3. Lower decorative chimney bracket
4. Flexible exhaust pipe
5. Lower decorative chimney(outer)
6. Hood mount bracket
7. Main body
8. Grease mesh filter*

* for BDRA603TBX, BDRA603TBX-F, 2 filters; for BDRA903TBX, BDRA903TBX-F, 3 filters

* Maximum extension of upper and lower chimney is 780mm

Technical data:

Power supply: 220 – 240v, 50Hz

Lights: 2x2W LED Light

Motor: 190W

Length of power cord: 1.5m Air

outlet diameter: 150mm

Operation Mode

Your range hood can be operated in two optional modes, choose the mode suitable for your kitchen before installation.

Air Extraction

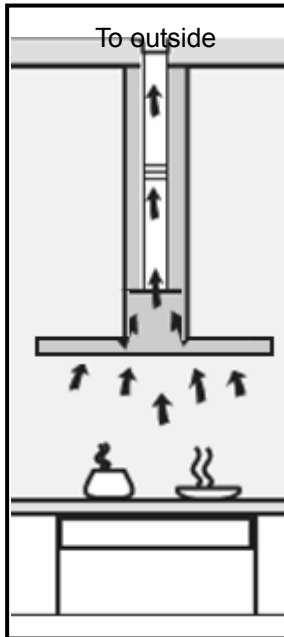

For air extraction mode, a ducting kit is required, the air is drawn in and cleaned by the grease filters and directed outside.

Ducting must be vented to outside atmosphere.

Air Recirculation

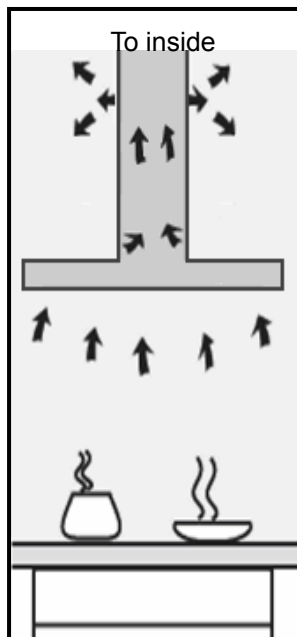

For air recirculation mode, charcoal filter is a must to eliminate cooking smells.

The air is drawn in and cleaned first by the grease filters and then charcoal filter. The cleaned air is then re-circulated back into kitchen through grilles on *the upper decorative chimney*.

Installation

Dimensions:

BDRA603TBX, BDRA603TBX-F Width=600

BDRA903TBX, BDRA903TBX-F Width=900

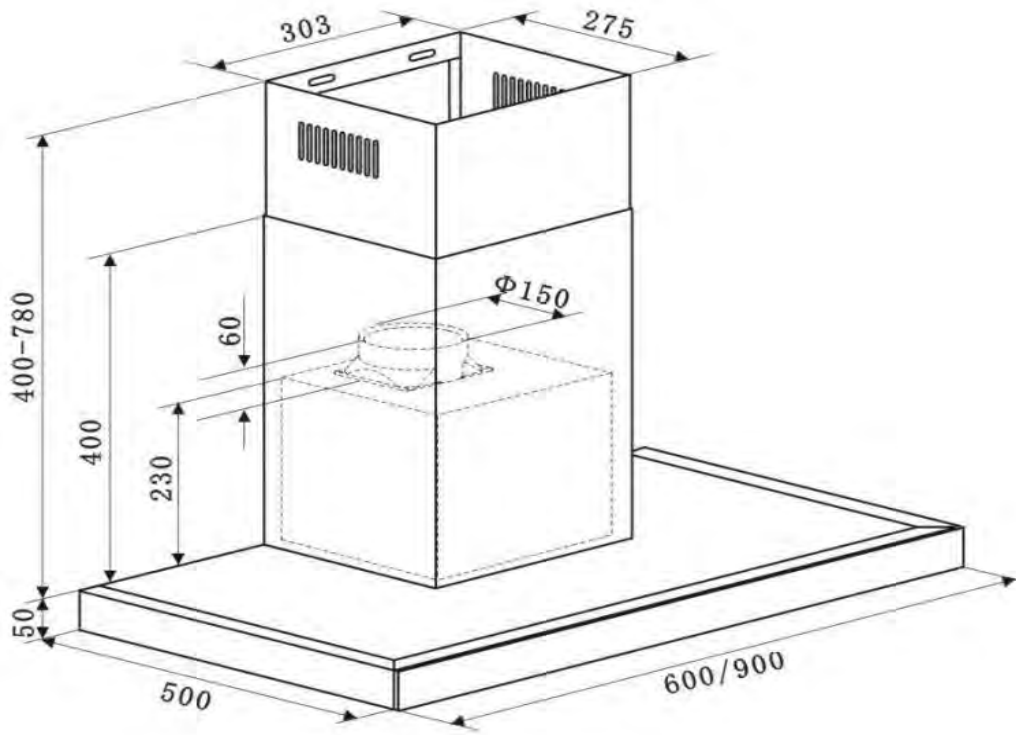

Installation:

Warning:

Check that the installation complies with the standards of local building, gas and electrical authorities. Before connecting to the mains supply ensure the mains voltage corresponds to the voltage on the appliance rating plate inside the range hood.

When installing the range hood, make sure you adhere to the minimum and maximum distances from the range hood base to the cooktop hob surface.

Hints for exhaust duct installation

The following rules must be strictly followed to obtain optimal air extraction

- Keep exhaust duct short and straight
- Do not reduce the size or restrict exhaust duct
- When using flexible duct always install the duct pulled taut to minimize pressure loss
- Failure to observe these basic instructions will reduce the performance and increase noise levels of the range hood

Ensure the exhaust ducting selected for installation complies with relevant standards and is fire retardant.

- Using a spirit level mark a vertical centre line on the wall where the hood is to be positioned, and a horizontal line where the hood base will be.

NOTE: The distance from the horizontal line to an electrical cooktop underneath must be minimum of 600mm & 650mm to the gas cook top and a maximum height of 750mm (refer to table below).

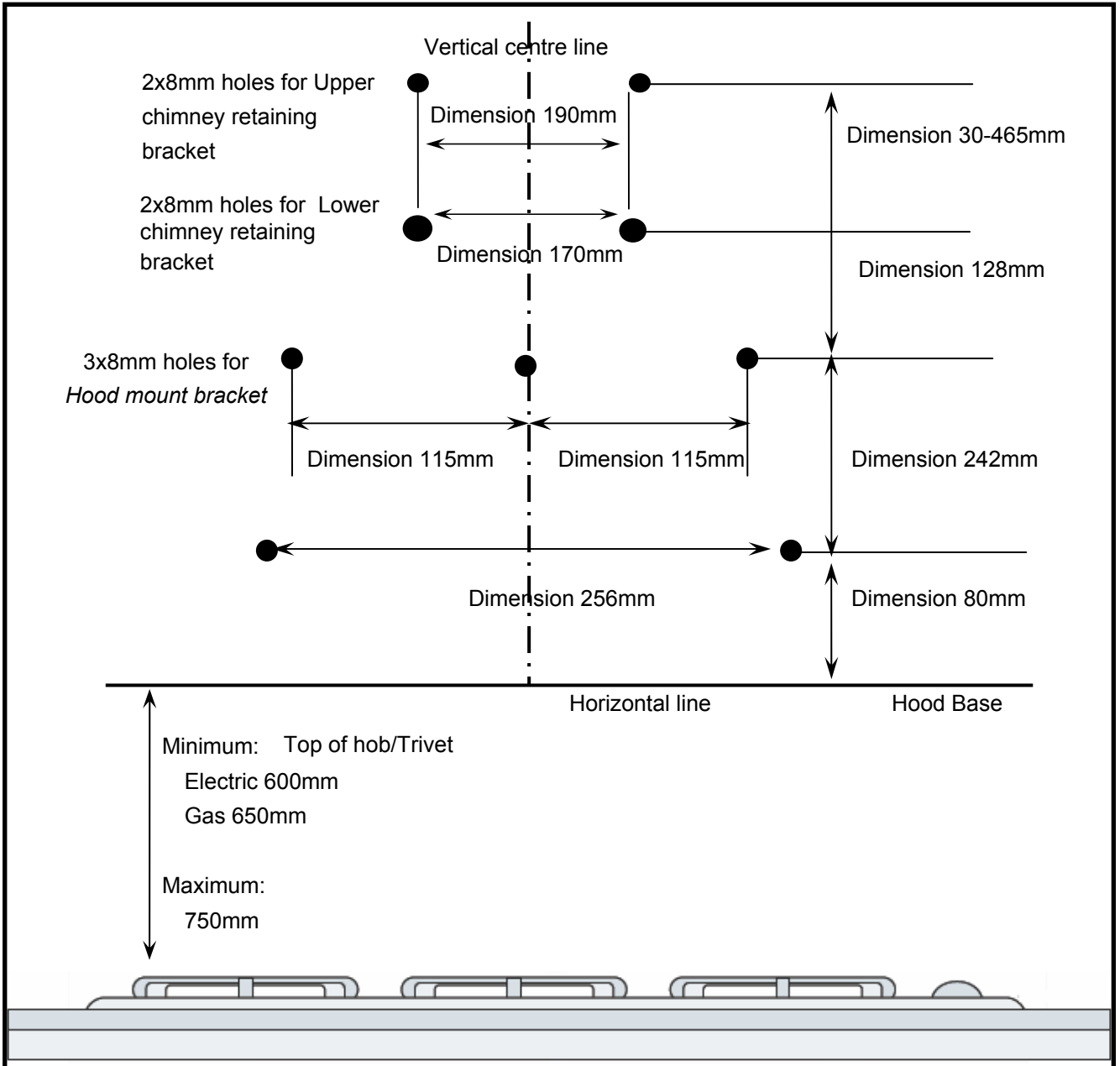

*If the instructions of the hob specify a greater distance than the minimum above, then that shall be the minimum height for installation

2. Based on above drawing and dimension to drill holes(8mm diameter) and hammer dry wall anchor plugs into holes.
3. Use 2 x ST4x8mm screws to attach lower and upper chimney together, do not fasten screws too much, make sure upper decorative chimney can be telescopically adjusted after assembled

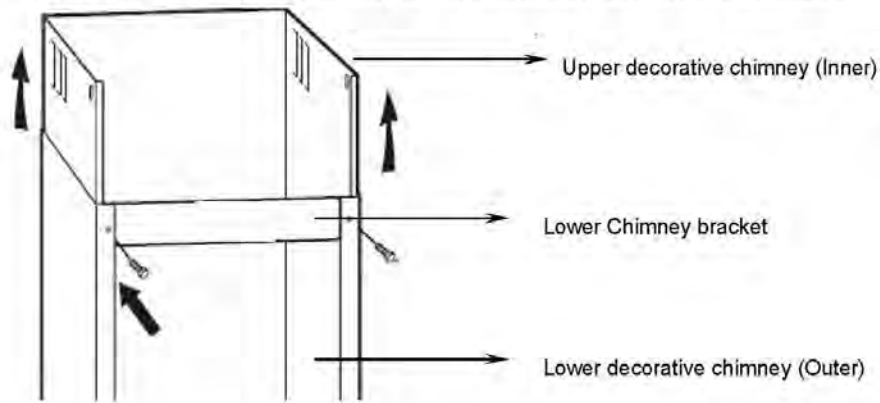

4. Fit the flexible exhaust pipe onto outlet with the 153mm end, use a strap to tighten the pipe.

**If you choose air extraction mode, please install the flexible exhaust pipe, if you choose air recirculation mode, no need to install the flexible exhaust pipe, please skip this step and jump to step 5*

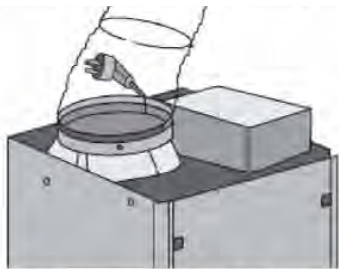

5. Remove the grease mesh filter and install active charcoal filter (Not Supplied) onto motor chamber refer below drawing.

**If you choose air extraction mode, please skip this step and jump to step 6, if you choose air recirculation mode, we strongly recommend to use a charcoal filter (Not Supplied). Charcoal Filters are available at your local Bunnings Part Number: CF110 Fineline:5102399*

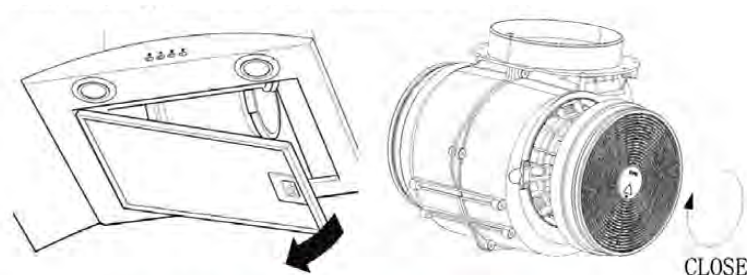

6. Secure the hood mount bracket onto wall with 3 x ST4 x 40mm screws, making sure screws are securely tightened. Secure the upper chimney bracket onto wall with 2 x ST4 x 30mm screws. Remove all blue protective film on chimney and cooker hood, the installation is now finished.

7. Hang on the hood onto the hook of the *hood mount bracket*, make sure the mount slot on cooker hood completely slide into hooks.

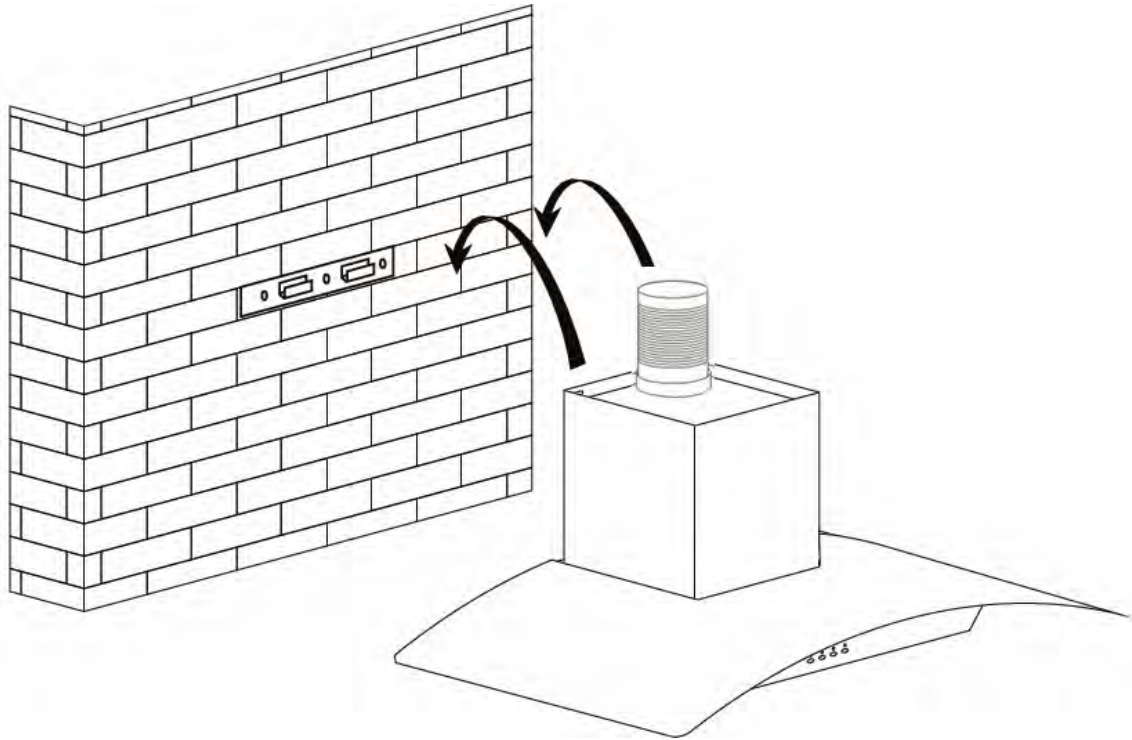

*Above photo is just for reference only, actual product could be varies...

8. Fasten the 2pcs anti-tilt ST4x30mm screws onto wall to ensure horizontality of rangehood. You can find out screw holes inside hood near the motor chamber.
9. Plug in the main power supply.
10. Attach the chimney onto the rangehood, secure the lower chiney onto the wall with 2 x ST4x40mm screws.
11. Extend the upper decorative chimney to desired height and fix it with the upper decorative chiney bracket by 2pcs ST4 x 8mm screws.

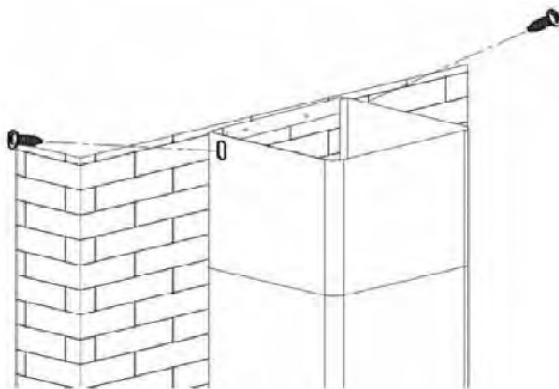



12. Remove all blue protective film on chimney and rangehood, the installation is now finished.

Start using your range hood

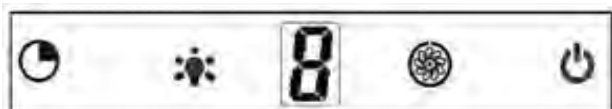
BDRA603TBX, BDRA603TBX-F, BDRA903TBX, BDRA903TBX-F



 **On/Off button** - Turn on/off unit,  **Speed increase/decrease**
 **Light button** - Turn on/off light

 **Digital display**
1 – Low fan speed; 2- Medium speed ; 3 - High speed.

 **Timer** - Range Hood Auto shut-off

1. With the Range Hood operating , by pressing the "Timer" button the appliance goes into 9 minute Auto shut-off mode.

The LED display will show count down time remaining status in full minutes from 9-8-7.....-1-0 ,and at reaching 0 will shut-off the Range Hood and light (If light On was also selected).

You can do this nearing the completion of cooking process or post cooking process to remove any remaining smells/condensation and not forget to turn it off for extended periods of time.

- 2.Repeated pressing will cycle appliance between Timer On or Off mode.
Timer can only be activated / deactivated if Range Hood fan is already operating.

Maintenance and cleaning

Caution:

- Before maintenance or cleaning is carried out, the range hood should be disconnected from the main power supply. Ensure that the range hood is switched off at the wall socket and the plug removed.
- External surfaces are susceptible to scratches and abrasions, so please follow below instruction to ensure the best possible result without damage.

GENERAL

Cleaning and maintenance should be carried out with the appliance cold especially when cleaning. Avoid leaving alkaline or acid substances (lemon juice, vinegar etc.) on the surfaces.

STAINLESS STEEL

The stainless steel must be cleaned regularly (e.g. weekly) to ensure long life expectancy. Dry with a clean soft cloth. A specialized stainless steel cleaning fluid may be used.

NOTE: Ensure that wiping is done along with the grain of the stainless steel to prevent any unsightly scratching patterns from appearing.

CONTROL PANEL SURFACE

The inlay control panel can be cleaned using warm soapy water. Ensure the cloth is clean and well wrung before cleaning. Use a dry soft cloth to remove any excess moisture left after cleaning.

Important

Avoid using harsh cleaning chemicals, strong household detergents or products containing abrasives as this will affect the appliance appearance and potentially remove any printing of artwork on the control panel and will void manufacturer's warranty.

GREASE MESH FILTERS

The mesh filters can be cleaned either by hand or in the dishwasher. After cleaning ensure that the filters are completely dry before refitting.

- By hand: Soak in warm water and a neutral washing up liquid. For stubborn grease stains use a soft nylon brush or sponge to help remove these stains. (Leave to dry naturally out of direct sun light)
- In a dishwasher: Ensure that placement of the filters is made so as to not impede the function of the

spray arm. Washing the filters in a dishwasher may cause discoloration of the aluminum inner mesh over time although it will not affect their performance. Filters should be washed separately to crockery and kitchen utensils. It is advisable not to use rinse aid.

Replace Halogen(Max 2W) LED lamp

1. Switch the unit off and unplug the appliance.
2. Disconnect the wire connector which is located within the hood (behind grease mesh filter)

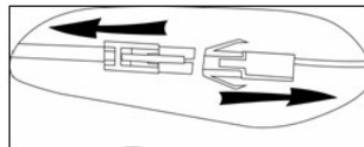

WARRANTY

- 1.1 In this warranty:
- 1.1.1 Australian Consumer Law means the law as set out in Schedule 2 of the Competition and Consumer Act 2010;
 - 1.1.2 **Company** means GSM Retail Australia Pty Ltd ABN 53 007 682 475 of 142-144 Fullarton Road, Rose Park SA 5067. Telephone 1300 373 199. Email admin@gsmretailaust.com.au;
 - 1.1.3 **Consumer** means a “consumer” as that term is defined in Section 3 of the Australian Consumer Law as the original purchaser of a Bellini product;
 - 1.1.4 **Consumer Guarantees** means the guarantees under the Australian Consumer Law;
 - 1.1.5 **You** means the Consumer.
- 1.2 Nothing in this warranty affects any person’s rights under the Australian Consumer Law. The benefits to any Consumer under this warranty are in addition to the rights and remedies available under any Consumer Guarantees.
- 1.3 Subject to the other clauses of this warranty, the Company warrants to the Consumer that the Bellini product will be free of manufacturing defects and will perform to the Company’s specifications.
- 1.4 The benefit of this warranty extends only to the Consumer as original purchaser of a Bellini product which is installed in a domestic household area.
- *The in Home warranty does not apply to Commercial and or industrial usage. *Please See 1.7.7 for additional information*
- 1.5 This warranty commences on the date of purchase of the Bellini product by the Consumer and continues for the benefit only of the Consumer until the expiry of three (3) year **(Warranty Period)**.
- 1.6 If within the Warranty Period a manufacturing defect is discovered in the Bellini product or it fails to perform to the Company’s specifications as a result of some defect in materials, components or workmanship (Defect) then the Company will, at its option, repair the Bellini product or supply a replacement Bellini product free of charge. A replacement Bellini product may differ from the original product purchased by the Consumer.
- 1.7 This warranty will not apply to any Bellini product:
- 1.7.1 Installed by any person other than a qualified tradesperson; or
 - 1.7.2 Subjected to misuse, neglect, negligence or accidental damage; or
 - 1.7.3 Operated in any way contrary to any operating or maintenance instructions; or
 - 1.7.4 Improperly handled, installed or maintained; or
 - 1.7.5 Altered or modified prior to or after installation; or
 - 1.7.6 Damaged directly or indirectly by power surges, electrical storm damage or connection to incorrect power supply
 - 1.7.7 Industrial and or Commercial usage is inclusive of staff areas in office/ shop environments, hotel/ motel or other similar accommodation or rental type properties including Bed and Breakfast establishments.

The Australian Consumer Law requires the inclusion of the following statement with this warranty:

Our goods come with guaranteed that cannot be excluded under the Australian Consumer Law. You are entitled to a replacement or refund for a major failure and for compensation for any other reasonably foreseeable loss or damage. You are also entitled to have the goods repaired or replaced if the goods fail to be of acceptable quality and the failure does not amount to a major failure.

**IN ORDER TO MAKE A CLAIM UNDER THIS WARRANTY THE CONSUMER
MUST CALL 1300 373 199 (AUSTRALIA) OR 088 764 912
(NEW ZEALAND) TO CONNECT TO THE NEAREST AUTHORISED CENTRE**

- 1.8 You must provide proof of your purchase of the Bellini product and the date of purchase in order to obtain the benefit of this warranty.
- 1.9 If you live outside the service area of the Company or one of its service agents, this warranty does not cover the cost of transport of the Bellini product for service nor the service agent's traveling costs to and from your home.
- 1.10 If you are required to transport the Bellini product to the Company or its service agent, you must ensure it is safely disconnected by a qualified tradesman and securely packed and insured. The Company does not accept any responsibility for loss or damage of the Bellini product prior to it being received by the Company or its service agent.
- 1.11 You will be responsible for all costs of returning a Bellini product to the Company and for redelivery of the Bellini product by the Company (whether it is the original or a repaired and/or a replacement Bellini product) and for any other expenses you incur in claiming under this warranty.
- 1.12 The Company or its service agent will examine any Bellini product and if the Company determines that it is defective through no fault of the Owner and is otherwise undamaged, the Company will repair or replace the Bellini product in accordance with this warranty.

DO NOT SEND IN THIS WARRANTY

Fill out the following details and file with your purchase invoice.

RETAIN & FILE WITH YOUR RECEIPT

Your Purchase Receipt/Invoice is proof of date of purchase. If you are unable to establish the date of purchase, or if the fault is not covered by this warranty, or if the product is found to be in working order, you will be required to bear all service call charges.

GSM Retail Australia Pty Ltd reserves the right to discontinue items, modify designs and change specifications without incurring obligation.

Whilst every effort is made to ensure that descriptions, specifications and other information in this publication is correct, no warranty is given in respect thereof and the company shall not be liable for any errors therein.

Purchased from:

Co. Name:

Address:

Date of Purchase:

Serial number:

NOTE: Consistent with our continuing product development policy, improvements may have been made which render the contents of this packaging slightly different to that shown.

**FOR WARRANTY SERVICE CALL 1300 373 199 (AUSTRALIA)
OR 0800 764 912 (NEW ZEALAND) TO CONNECT YOU TO THE NEAREST
AUTHORISED SERVICE CENTRE**

